

Global Product Catalog

CT, Interventional Radiology, Ultrasound
and Emergency Department

Origin[®]

General Purpose GP Drainage Catheter[™]
with locking pigtail



- The Origin Catheter is the culmination of years of research and development.
- Origin now features a clear hub for better visualization, an improved catheter material for insertion ease, an improved tip taper, the largest holes currently available on the market and depth marks that can confirm catheter position.
- Every Origin General Purpose Catheter (GP) includes the following; Catheter, Metal Cannula, Flexible Cannula, Trocar and Hydrophilic Coating. The 6F catheter also includes an obturator.
- Origin Catheters are available in 6F through 16F diameters.

Product Code	Size/Length	Units/Box
GPL2-0625H	6 F / 18 cm	5
GPL2-0830H	8 F / 21 cm	5
GPL2-1030H	10 F / 21 cm	5
GPL2-1230H	12 F / 20 cm	5
GPL2-1430H	14 F / 21 cm	5
GPL2-1630H	16 F / 21 cm	5



Origin[®] Mini-Pigtail[®]

Drainage Catheter with locking pigtail



- UreSil's "MiniPig" (MP) Catheter is very similar to the General Purpose Catheter but is designed with a reduced size pigtail that presents a smaller footprint within an abscess, and is generally used for abscesses near critical structures.
- Every MiniPig General Purpose Catheter includes the following; Catheter, Metal Cannula, Flexible Cannula, Trocar and Hydrophilic Coating. The 6F catheter also includes an obturator.
- MiniPig Catheters are available in 6F, 8F and 10F diameters.

Product Code	Size/Length	Units/Box
MPL2-0625H	6 F / 20 cm	5
MPL2-0830H	8 F / 25 cm	5
MPL2-1030H	10 F / 25 cm	5



Origin[®] Short Mini-Pigtail[®]

Drainage Catheter with locking pigtail



- UreSil's Short MiniPig Catheter (KDL) has an overall length of only 17cm.
- This catheter was developed to assist with the drainage of abscesses closer to the surface or in patients with smaller anatomy.
- Every KDL Catheter includes the following; Catheter, Metal Cannula, Trocar and Hydrophilic Coating
- Short MiniPig Catheters are available in 6F, 8F, and 10F diameters

Product Code	Size/Length	Units/Box
KDL2-0617H	6 F / 12 cm	5
KDL2-0817H	8 F / 12 cm	5
KDL2-1017H	10 F / 12 cm	5



Origin[®] General-Purpose

Drainage Catheter with “J” tip



- UreSil's Non-Locking General Purpose Catheter (GPJ) offers all of the features of our General Purpose Catheters but in a non-locking format.
- Every GPJ Catheter includes the following; Catheter, Metal Cannula, Trocar and Hydrophilic Coating.
- GPJ Catheters are available in 6F through 14F diameters.

Product Code	Size/Length	Units/Box
GPJ-0620H	6 F / 15 cm	5
GPJ-0825H	8 F / 19 cm	5
GPJ-1025H	10 F / 19 cm	5
GPJ-1225H	12 F / 19 cm	5
GPJ-1425H	14 F / 20 cm	5



Origin[®] ULTI-flo[®]

Large I.D. with aspiration flush
Adapter with locking pigtail



AFA-LB

- UreSil's Ulti-flo Locking Catheter (LBL) was designed to solve a common problem with flow dynamics in abscess drainage.
- The internal diameter of a standard luer connection is roughly equivalent to the internal diameter of a 12F catheter. When a 14F or 16F catheter with standard luer lock is employed, the inner lumen of the luer lock creates a choke point for drainage.
- The LBL utilizes a patented hub that maintains 14F or 16F drainage from the catheter all the way to the drainage bag. This maximized lumen minimizes the potential for blockages.
- Every LBL kit comes with the following: Catheter, Metal Cannula, Trocar, Flexible Cannula, Large Bore Aspiration / Flush Adapter and Large Bore Syringe Adapter.
-
- UreSil's Ulti-flo catheters are available in 14F and 16F diameters.

Product Code

Size/Length

Units/Box

LBL2-1430HB
LBL2-1630HB

14 F / 19 cm
16 F / 20 cm

5
5



ULTI-flo[®] 20+

General Purpose Catheter (non-locking)

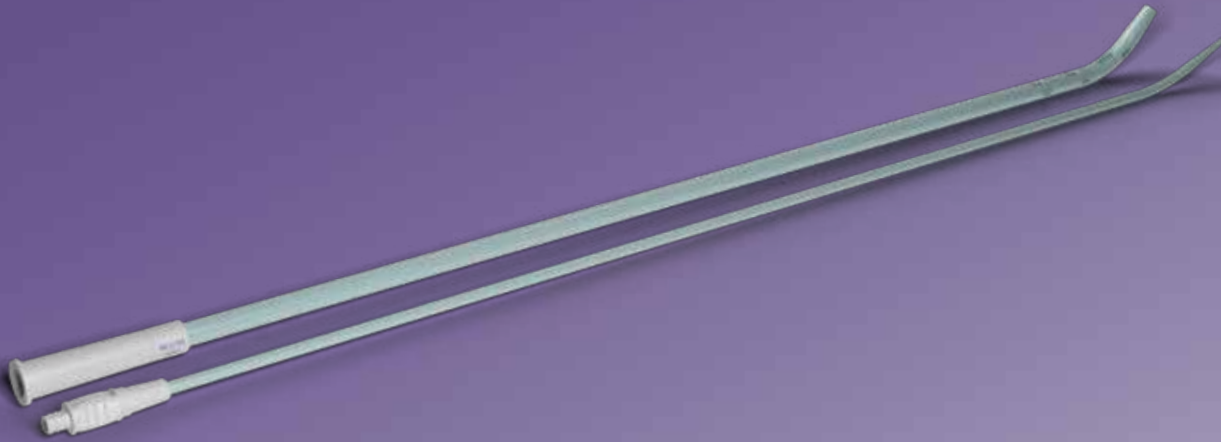

- UreSil's 20+ Non-Locking Catheter (LBNL) was born from the necessity to provide 20F, 24F and 28F catheters for interventional drainage. Ulti-flo catheters possess a radiopaque stripe to increase visualization during introduction and are made of a softer material that provides flexibility and comfort while dealing with large abscesses or other fluids such as pancreatic pseudocysts.
- Every set includes the following: Catheter and Introducer that accommodates either .035" or .038" guidewire.

Product Code	Size/Length	Units/Box
LBNL-2050H	20 F / 41 cm	5
LBNL-2450H	24 F / 41 cm	5
LBNL-2850H	28 F / 41 cm	5



Origin[®] NEPHRO-CATH[™]

Neophrostomy Drainage Catheter
with locking pigtail



- UreSil's Nephrostomy Catheter (NCL) includes all of the features found in the General Purpose Catheters except for a trocar, and is approximately 5 cm longer to allow for placement within the kidney for drainage.
- UreSil has a longer 50 cm version of this catheter to accommodate larger patients where increased length is necessary.
- Every NCL catheter is available in 8F-14F diameters and includes the following: Catheter, Metal Cannula, Flexible Cannula and Septum cap.

Product Code	Size/Length	Units/Box
NCL2-0835H	8 F / 28 cm	5
NCL2-1035H	10 F / 28 cm	5
NCL2-1235H	12 F / 27 cm	5
NCL2-1435H	14 F / 28 cm	5

Product Code	Size/Length	Units/Box
NCL2-0850HB	8 F / 41 cm	5
NCL2-1050HB	10 F / 41 cm	5
NCL2-1250HB	12 F / 40 cm	5
NCL2-1450HB	14 F / 40 cm	5



Origin[®] CHOLE-CATH[®]

Biliary Drainage Catheter
with locking pigtail



- UreSil offers wide array of Biliary Catheters (CCL).
- All Biliary Catheters come with a radiopaque (RO) marker located adjacent to the proximal hole to facilitate proper placement under imaging guidance.
- All regular (HB) Biliary Catheters are available in 8F to 16F diameters, and have holes up the shaft approximately 9.5 cm from the curled pigtail.
- All extended hole Biliary Catheters (HBX) are available in 8F-12F diameters with additional holes extending up the shaft approximately 16 cm from the curled pigtail.
- Every Biliary Catheter includes the following: Catheter, Metal Cannula, Flexible Cannula, Septum Cap and RO Marker

Product Code	Size/Length	Units/Box
CCL2-0850HB	8 F / 41 cm	5
CCL2-1050HB	10 F / 41 cm	5
CCL2-1250HB	12 F / 40 cm	5
CCL2-1450HB	14 F / 40 cm	5
CCL2-1650HB	16 F / 40 cm	5

Product Code	Size/Length	Units/Box
CCL2-0850HBX	8 F / 41 cm	5
CCL2-1050HBX	10 F / 41 cm	5
CCL2-1250HBX	12 F / 40 cm	5



Origin[®] CHOLE-CATH[®]

Biliary Drainage Catheter with locking pigtail



Origin[™] NEPHRO-CATH[™]

Nephrostomy Drainage Catheter with locking pigtail



Origin CHOLE-CATH Biliary Drainage Catheter Kit with RO Marker
UreSil's Biliary Kits include items needed to perform a biliary procedure.

Product Code	Size/Length	Units/Box
CCL2-0850HB-K	8 F / 41 cm	5
CCL2-1050HB-K	10 F / 41 cm	5

Origin NEPHRO-CATH Nephrostomy Drainage Catheter Kit
UreSil's Nephrostomy Kits include items needed to perform a nephrostomy procedure.

Product Code	Size/Length	Units/Box
NCL2-0835HB-K	8 F / 28 cm	5
NCL2-1035HB-K	10 F / 28 cm	5

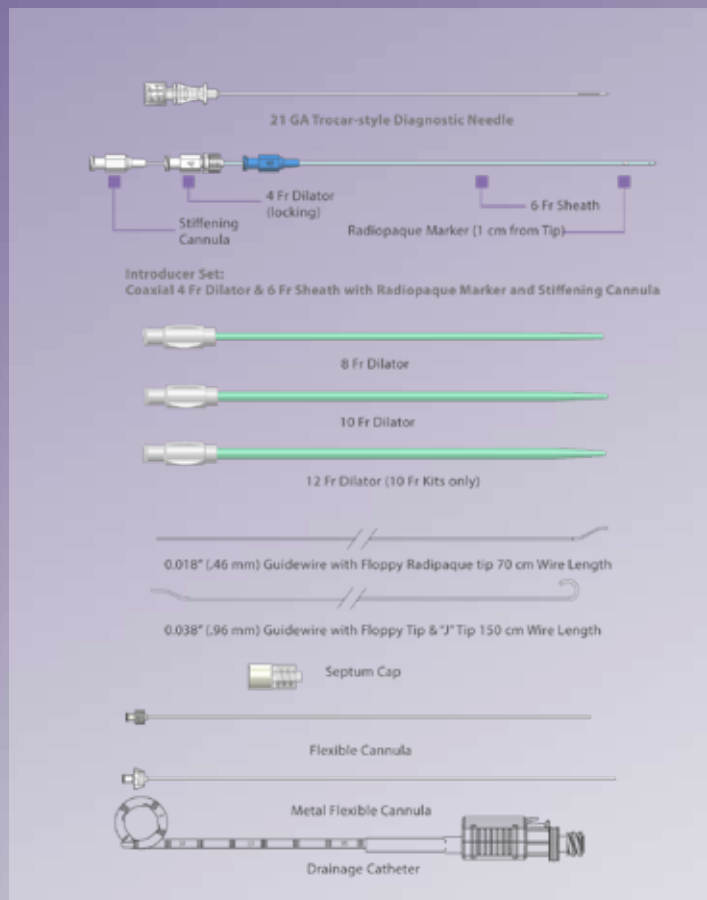

The kits are available in 8F and 10F diameters and include the following:

- Catheter
- Metal Cannula
- Flexible Cannula
- Septum Cap
- Introducer Set with Radiopaque Tip (Coaxial 4F/6F dilator set with cannula)
- 21 GA needle with Echogenic Tip
- .018", 70cm long Nitinol Guidewire with Floppy Radiopaque Tip
- .038", 150cm long Guidewire
- 8F and 10F Dilators (10F kits also contain 12F Dilator)



Origin[®] NEPHRO-STENT[™]

Nephroureteral Stent Catheter
with locking pigtail



- Features include an increase in the number of drain holes, a highly visible radiopaque (RO) marker, a smaller bladder pigtail, a rigid cannula and a flexible cannula with obturator to facilitate placement.
- Every NU Stent Catheter includes the following; Catheter with RO Marker, Metal Cannula, full length Flexible Cannula with Obturator, Septum Cap and Hydrophilic Coating.

Product Code	Length Between Pigtailed	Size/Length	Units/Box
NSL2-0822H	22 cm	8 F / 66 cm	5
NSL2-0824H	24 cm	8 F / 68 cm	5
NSL2-0826H	26 cm	8 F / 70 cm	5
NSL2-0828H	28 cm	8 F / 72 cm	5
NSL2-1022H	22 cm	10 F / 66 cm	5
NSL2-1024H	24 cm	10 F / 68 cm	5
NSL2-1026H	26 cm	10 F / 70 cm	5
NSL2-1028H	28 cm	10 F / 72 cm	5



THORA VENT[®]

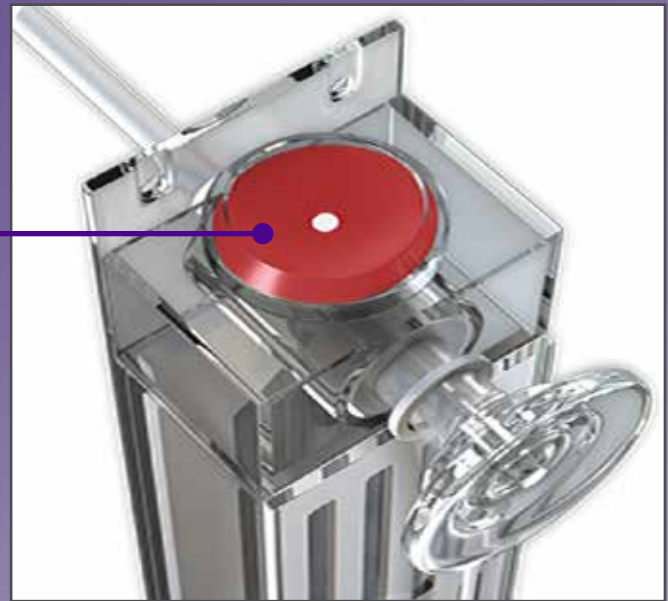
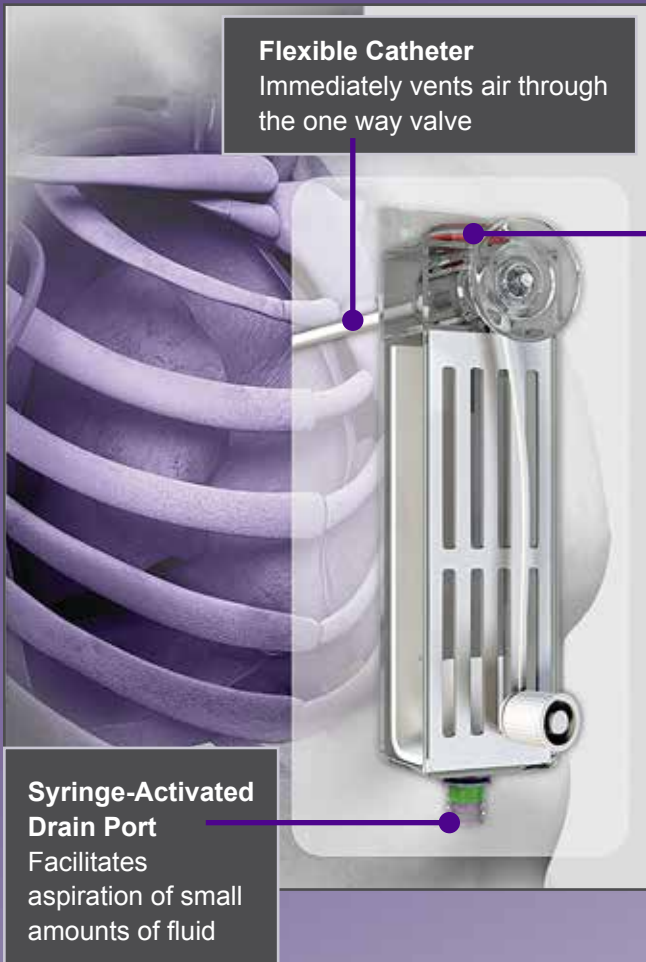

Red Signal Diaphragm

- Fluctuation demonstrate entry of the catheter into the pleural cavity with pressures greater than 2mm Hg and less than - 2mm Hg
- Continues to fluctuate with respiration until the pneumothorax is resolved as confirmed by x-ray

- UreSil's flagship product, the Thora-Vent has become one of the most commonly accepted choices for physicians treating simple pneumothorax throughout the world.
- Thora-Vent is unique in that it allows for active monitoring of the patient's pneumothorax during treatment and provides for maximum ambulation as well.
- Available in multiple sizes, Thora-Vent is an excellent option for the resolution of simple pneumothorax.
- Available with an over the wire insertion option.
- Every kit includes the following: Thora-Vent with Trocar, Aspiration Cannula, Suction Tubing Set, 60cc Syringe, Halstead Forceps, Vent Occlusion Plug, Gauze Sponges, Protected Disposable Scalpel, CSR Wrap and Fenestrated Drape.

THORA-VENT Procedure Tray		
Product Code	Size/Length	Units/Box
TV11-10	11 F / 10 cm	1
TV11-13	11 F / 13 cm	1
TV13-10	13 F / 10 cm	1
TV13-13	13 F / 13 cm	1

THORA-VENT Accessories		
Product Code	Description	Units/Box
TVST	Thora-Vent Suction Tubing	5
TVOCP	Vent Occlusion Plug	5
OTW11-13	Over-the wire insertion Cannula for TV11-13	5



Evolution[®]

Evacuated Suction Bottles

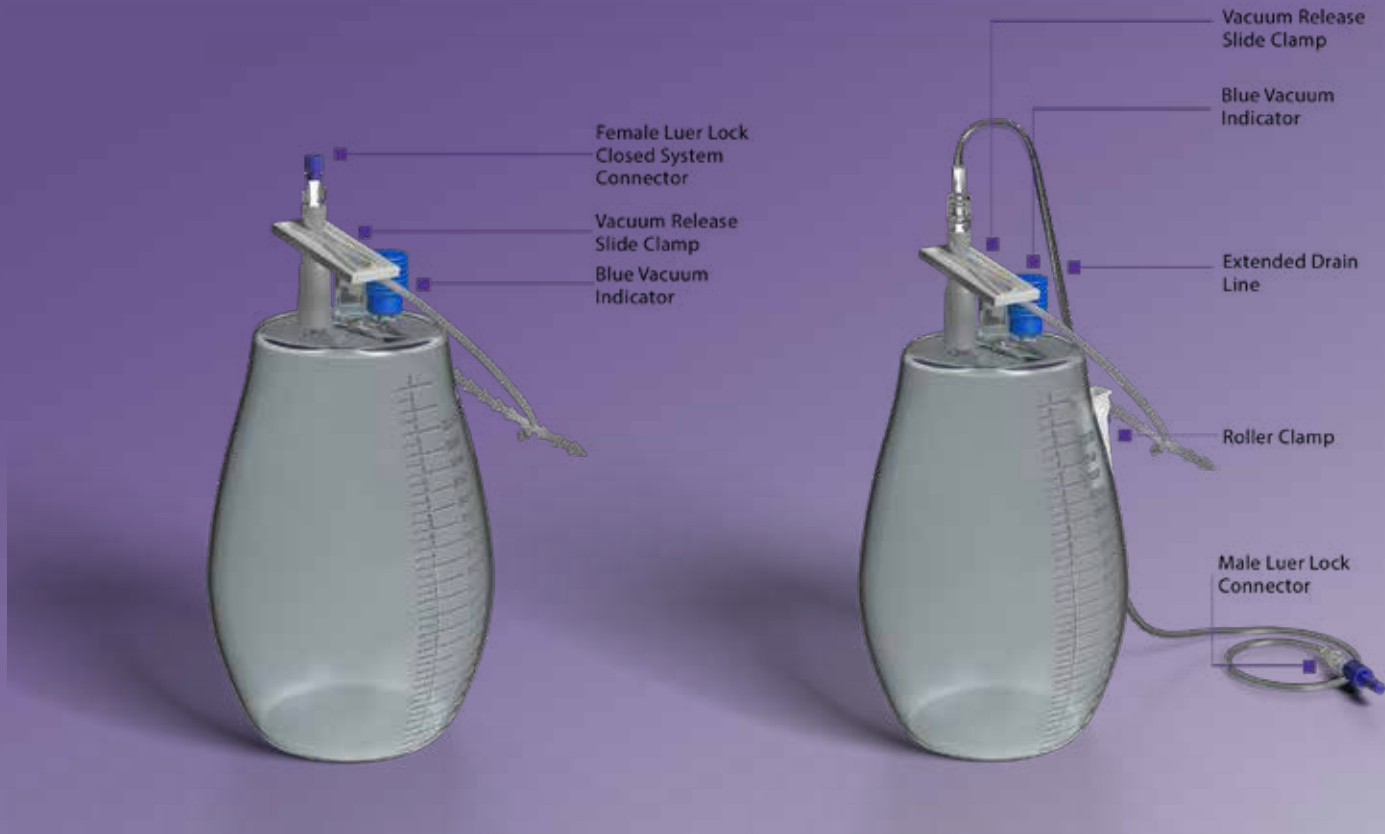

ESB-1000SP Non-Sterile

ESB-1000FS-T Sterile Drain Line

- The Evolution line of evacuated suction bottles is widely used for paracentesis, thoracentesis and other drainage procedures.
- The Evolution Bottle is not made from glass and is reliably available for purchase.
- The available male-to-male luer connecting tubing allows for flow while eliminating the need for a “spike” tubing required for other methods.
- Evolution is reliable and cost effective. Additionally, Evolution is not made with natural rubber latex.
- These bottles are available in a non-sterile format with sterile tubing sold separately or packed in a sterile pouch with tubing already connected.
- The unique roller clamp design provides an easy way to control the flow of fluids if desired.

Product Code	Size/Length	Units/Box
ESB-1000SP	1000 ml Evacuated Bottle w/ Luer Connection Only, Non-Sterile	12
ESB-1000FS-T	1000 ml Evacuated Bottle w/ Sterile Drain Line (120 cm)	10
ESB-ST	Sterile Tubing Only (120 cm)	10

Not available where CE mark is required for sale



Symphony®



Symphony® MAX



Symphony and Symphony MAX Procedure Kits Include:

- Centesis Catheter 5F or 6F
- 10.5ml Clear Chloraprep
- Fenestrated Drape
- (6) Gauze 4x4
- Skin Marker
- 18G Safety Needle
- 25G Safety Needle
- Safety Needle Holder
- Safety Scalpel
- 3 Way Stopcock
- 10mL Syringe
- 60mL Syringe
- Syringe Cap
- Blue OR Towel
- (3) 10mL Specimen Tubes
- Adhesive Bandage

Symphony is a rapid deployment, high volume, high flow-rate 5 french centesis kit that includes the most commonly used components for these procedures. Symphony MAX is a complete kit as well that offers even higher flow rates and higher volume drainage by utilizing a 6F Centesis Catheter.

Not available where CE mark is required for sale

Product Code	Description	Units/Box
CTK-5	Symphony Centesis Kit	8
CTK-6	Symphony MAX Centesis Kit	8
CTK-00	Procedure Kit Only, No Catheter	8



TRU-CLOSE®

TCS Suction Drainage Bag

- UreSil's most widely recognized product is the TRU-CLOSE TCS Suction Drainage Bag.
- This product will attach to any luer locking drainage catheter and can remove fluids using active suction or gravity.
- Available in a variety of sizes and configurations, every TRU-CLOSE bag has two anti-reflux valves, provides active suction and is simple and intuitive to operate.
- TCS Bags are available in 300ml, 500ml and 1,000ml configurations and can come with or without a drain port in all sizes except for the 1,000ml version.

Product Code	Description	Units/Box
TCS500	500 ml w/o Drainage Port	10
TCS1000	1000 ml w/o Drainage Port	10
TCS500D	500 ml with Drainage Port	10
TCS300D	300 ml with Drainage Port Low profile bellows	10
TCS500DS	500 ml with Drainage Port Low profile bellows	10

TCS500DS



TCS1000



TCS300D



Optimus[®]

Gravity Drainage Bag



Product Code	Description	Units/Box
TC600	Gravity Drainage System with 600 ml drainable collection bag, elastic hook-and-loop belt and 20" stretchable tubing with luer lock connector	20
TC600L	Gravity Drainage System with 600 ml drainable collection bag, elastic hook-and-loop belt and 36" stretchable tubing with luer lock connector	20

- UreSil's Optimus Gravity Drainage Bags are made from a high quality plastic film, provide reliable collection, and have become one of the most widely purchased gravity bag products for interventional drainage.
- The TC600 comes with a 600ml drainable collection bag, 20" of stretchable, resizable tubing, a luer lock connector, a loop belt and an elastic hook.
-
- The TC600L is identical, but comes equipped with 36" of stretchable, resizable tubing with a luer lock connector.



Aspiration Flush Adapters

AFA-LL

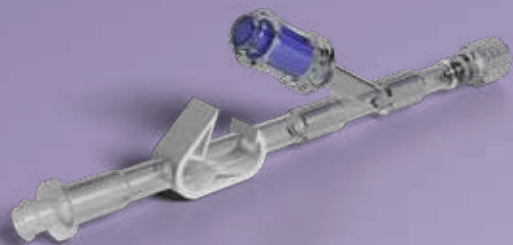

- The Aspiration Flush Adapter with Luer Lock Connections was developed based upon multiple clinical requests.
- In essence, this product replaces the flow limiting three way stop-cock with something reliable, intuitive and easy to use for patients, physicians and nurses all over the world.
- The AFA-LL can be used with any bag and any catheter commonly found in practice today.

AFA-LB

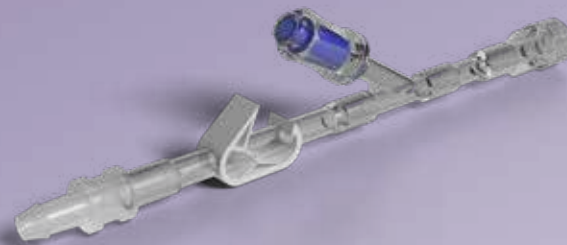

- The AFA-LB is identical to the device provided in our LBL Catheter Kits.
- The AFA-LB allows connection of the UreSil LBL catheter to any standard drainage bag.

Product Code

Units/Box

AFA-LL

5

Product Code

Units/Box

AFA-LB

5



DFA-LL

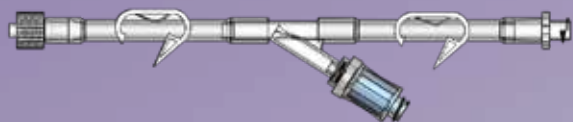

- Similar to the AFA-LL but includes an additional clamp that can be used to allow flushing towards the catheter or the bag.

UFA-LL

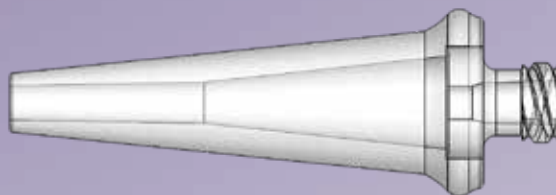

- This device was created to provide a way to adapt funnel connections to luer connections.
- Compatible with UreSil's ULTI-Flo[®] 20+ General Purpose Catheters (LBNL).

Product Code

Units/Box

DFA-LL

5

Product Code

Units/Box

UFA-LL

5



PDC-36

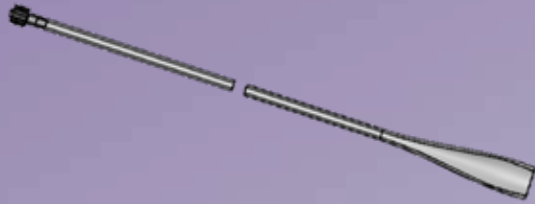

- PDC-36 multipurpose tubing is 36" in length. Most common uses include connecting a basic urinary drain bag or water seal device to any standard drainage catheter by utilizing a luer connection.

TCY2

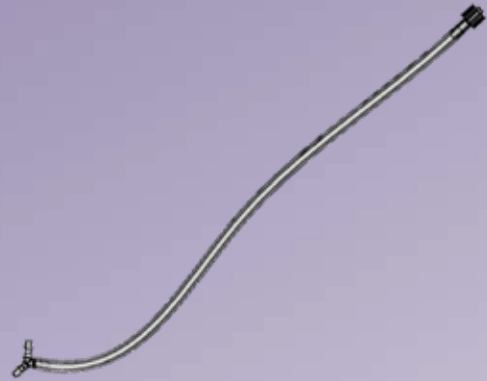

- The TCY2 tubing is used to offer bilateral drainage to a single bag.

Product Code

Units/Box

PDC-36

5

Product Code

Units/Box

TCY2

5



FORTITUDE[®]

Universal Catheter Fixation Device

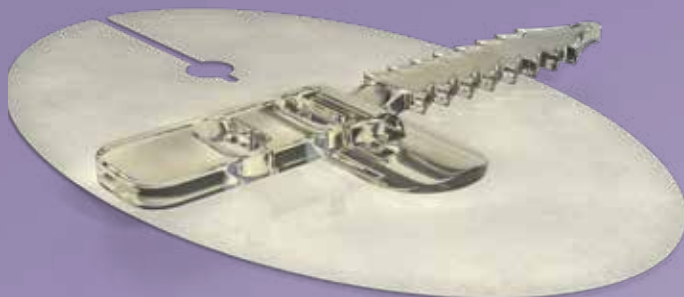

Fortitude is a device that was developed to address the consistent clinician requests for a universal fixation device that would stand up to the day to day activities of patients on an inpatient or outpatient basis. The call was to also have an adhesive that is hypoallergenic and rugged as to adhere well to a variety of skin conditions without causing irritation or further complications. Fortitude addresses these concerns and also does not contain any rigid plastic parts that can cause further patient discomfort while providing incredible securement of any common catheter.

Product Code	Description	Units/Box
SG-0232	Universal Catheter Fixation Device Accommodating 3F-32F Sizes	30

Not available where CE mark is required for sale.

- Hydrocolloid adhesive material for secure, hypoallergenic adhesion to patient skin.
- Dressing can be used in an occlusive and non-occlusive manner.
- Soft, secure strap to assist in reducing patient discomfort.
- Truly universal fit that accommodates 3F-32F sizes.

- Developed in conjunction with one of the busiest cancer institutes in America, the TRU-FIX Catheter Fixation Device provides for reliable and consistent catheter fixation.
- Available in multiple sizes to suit your needs, this product includes: Fixation Disk with Securing Clamp and Adhesive Dressing.
- Replacement Adhesive Dressing also available.

TRU-FIX[™] Fixation Devices

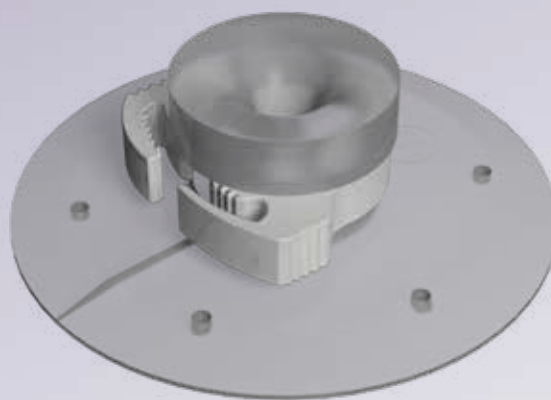

Product Code	French Size	Units/Box
TFK-06	6F	5
TFK-08	8F	5
TFK-10	10F	5
TFK-12	12F	5
TFK-14	14F	5
TFK-16	16F	5

Replacement Adhesive Dressing Product Code	Units/Box
TFD-R	20



Posi-Stick[®]

Introducer Sets

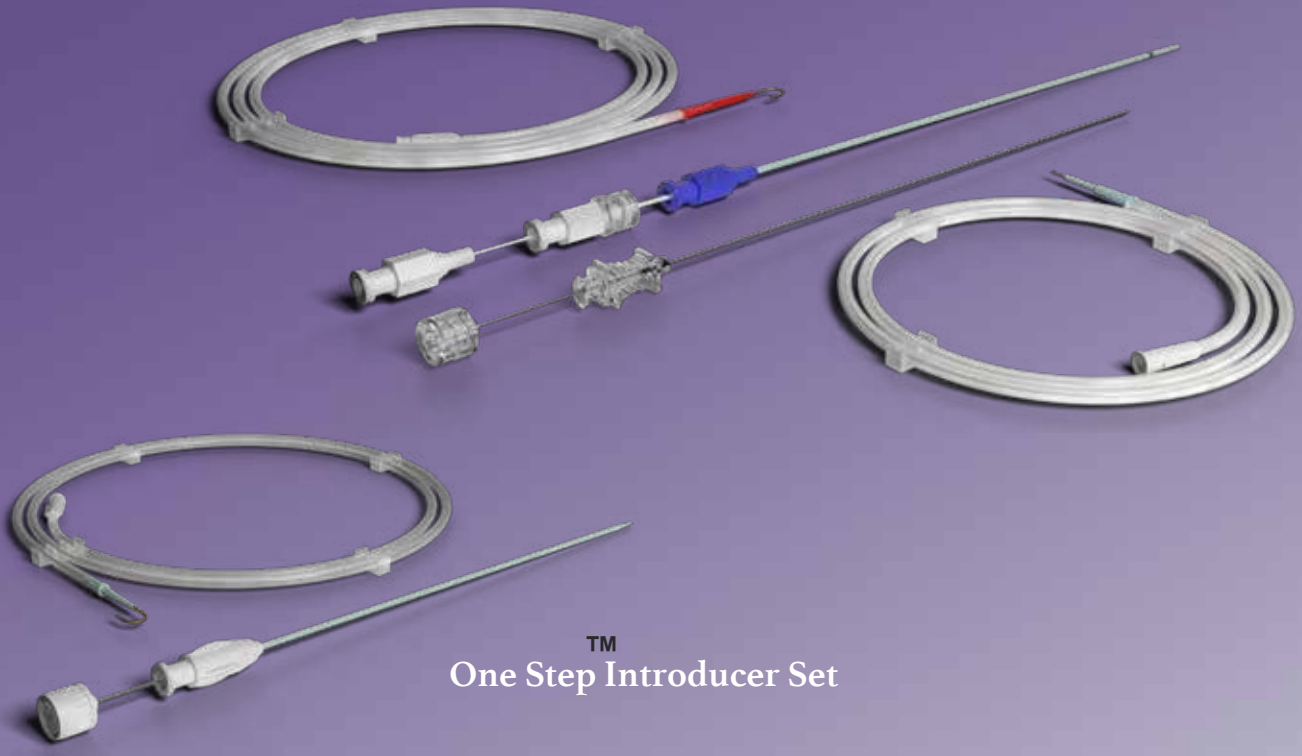

TM One Step Introducer Set

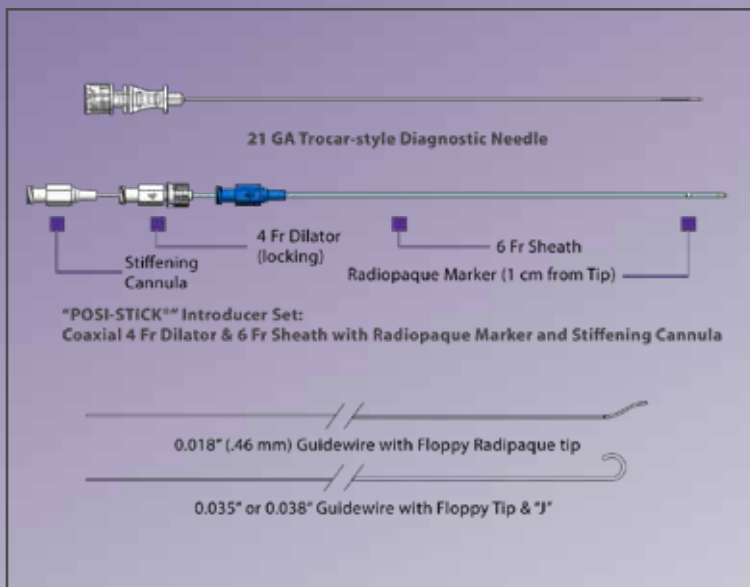

Product Code	Diagnostic Needle (21 GA)	"POSI-STICK" Introducer Set	Nitinol Guidewire (.018" 70 cm length)	Guidewire (.038" 150 cm length)	Guidewire (.035" 150 cm length)	Dilator (5 Fr) with locking trocar	Guidewire (.038" 100 cm length)	Units per Box	
PS2-38	✓	✓	✓	✓				5	
PS2-35	✓	✓	✓			✓		5	
PS2-18*				✓				10	
PS2-00	✓	✓	✓					10	
PS2-15							✓	✓	5

* Replacement 0.018" (.46 mm) Guidewire for PS2-35 & PS2-38

PS2-15 is not available where CE mark is required for sale.

"POSI-STICK" Set Configurations



Products manufactured in U.S.A. by:



UreSil, LLC, 5418 W. Touhy Ave.,
Skokie, IL 60077
Tel: (800) 538-7374 Tel: (847) 982-0200
Fax: (847) 982-0106

THORA-VENT, Mini-Pigtail, UreSil, CHOLE-CATH, Optimus, Fortitude, Evolution, TRU-CLOSE, ULTI-flo, Origin, Symphony, and POSI-STICK are registered trademarks of UreSil, LLC. GP, NEPHRO-CATH, NEPHRO-STENT, TRU-FIX, and One Step are trademarks of UreSil, LLC.

**Products covered by one or more of the following U.S. patents: 6,770,063; 8,177,773; 9,079,006B1; DES. 585,134S
Doc. no. MK-UPC Rev 02/18/2020 © 2020 UreSil, LLC**

Terms are Net 30 Days. All shipments are F.O.B. Skokie, Illinois. Prices are subject to change without notice.

RETURNED GOODS:

Approval to return merchandise is required for all returns. Contact UreSil Customer Service for a Return Goods Authorization Number at 800-538-7374. The request for returns should include the reason, catalog number, lot number and UreSil Invoice number. All items must be returned unopened, in full boxes only and are subject to a 20% restocking charge. Returns will only be accepted within ninety days of date of invoice. Material that has been opened, damaged or tampered with is not returnable for credit. Products manufactured as CUSTOM products are not returnable for credit.

